

Blustyle
by COTTO D'ESTE

BLUTECH
UNIQUE ELEGANCE



Blustyle[®] | BELLA
PER
SEMPRE
by COTTO D'ESTE



BLUTECH
UNIQUE ELEGANCE



BLUTECH UNIQUE ELEGANCE

Blutech è un progetto ceramico in gres porcellanato a tutta massa composto da materie prime purissime.

Blutech è frutto di una innovativa tecnologia produttiva e di una scrupolosa ricerca per ottenere finiture superficiali senza eguali. Il risultato è un prodotto bellissimo e moderno, tecnicamente superiore, resistente, planare e garantito fino a 20 anni.

Le cinque sorprendenti superfici, i sei colori moderni e i tre formati ne fanno una collezione completa, elegante e versatile.

Blutech è pensata per accompagnare la vita moderna in ogni sua attività ed ambito: dagli spazi di lavoro, pubblici e ad alto traffico, a quelli di prestigio, residenziali e di lusso.

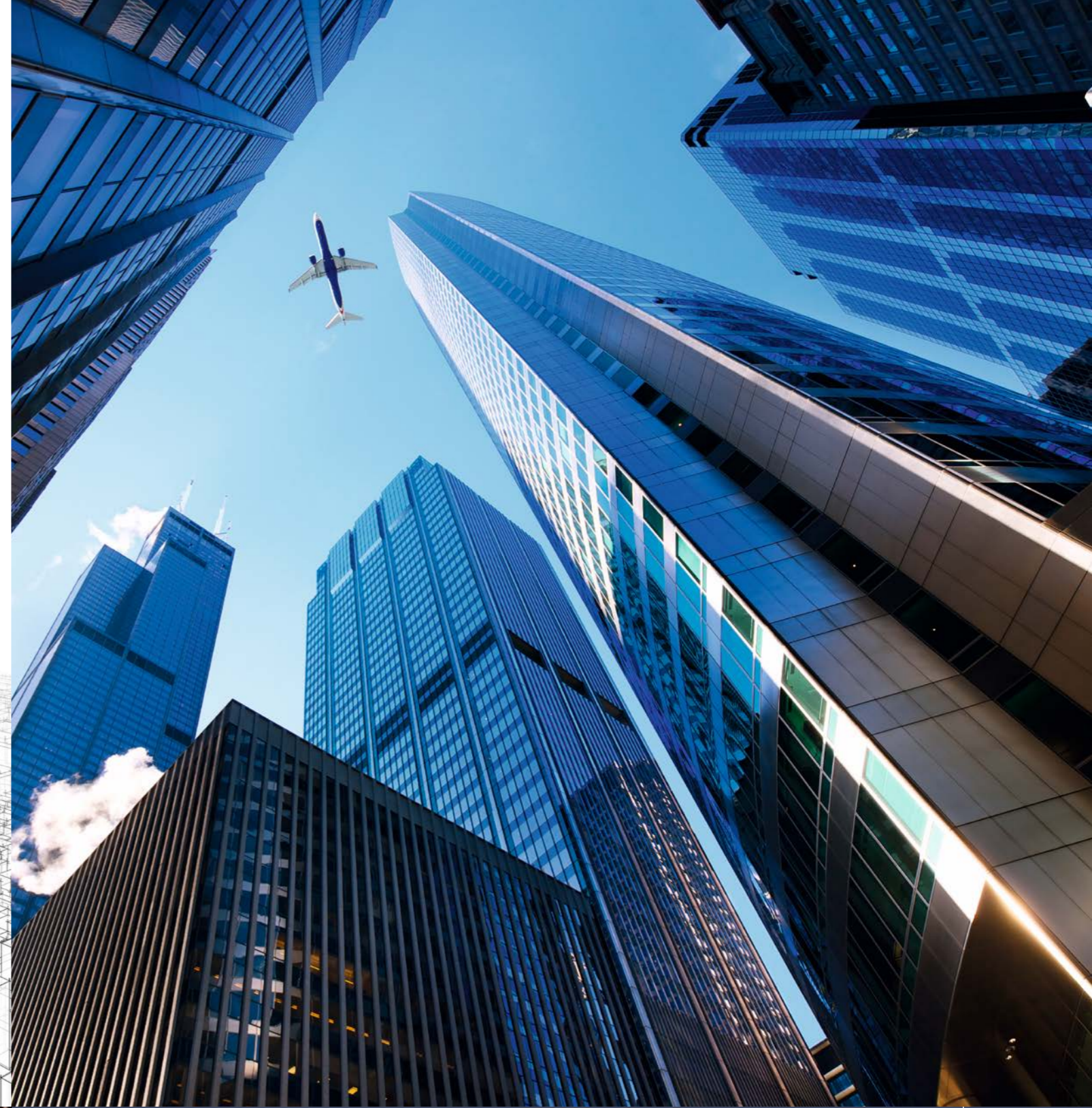

Blutech is a ceramic project in full body porcelain stoneware made from the purest raw materials. Blutech is the product of innovative manufacturing technology and scrupulous research aimed at obtaining unparalleled surface finishes.

The result is a beautiful and modern product that is technically superior, durable, flat, and guaranteed for up to 20 years.

The five surprising surfaces, six modern colours, and three formats make up a complete, elegant, and versatile collection.

Blutech is designed to accompany modern life in all of its activities and settings: from public and high-traffic work spaces to prestigious, residential, and luxurious environments.



PROCESSO PRODUTTIVO UNICO

UNIQUE PRODUCTION PROCESS

Blutech è la collezione tecnica in gres porcellanato più evoluta presente oggi sul mercato. Le eleganti sfumature tono su tono e la grande resistenza sono ottenute grazie ad un'innovativa tecnica di "Doppio caricamento". Attraverso questo processo tecnologico esclusivo e brevettato materie prime finissime micronizzate e granuli di gres colorato vengono miscelati a tutta massa in due strati sovrapposti, che vengono poi pressati insieme con una forza di 7.500 tonnellate. Questa perfetta compattazione conferisce al prodotto una straordinaria resistenza all'urto.

Blutech is the most highly evolved porcelain stoneware technical collection currently present on the market. The elegant tone-on-tone shades and its outstanding durability are obtained thanks to an innovative "Double loading" technique. Through this exclusive and patented technological process, the purest micronized raw materials and granules of coloured stoneware are fully combined in two overlapping layers which are then pressed together with the pressure of 7,500 tonnes. This perfect compaction gives the product an extraordinary resistance to impact.

BLUTECH



SECONDO CARICAMENTO
SECOND LOADING

PRIMO CARICAMENTO
FIRST LOADING

La bellezza di questa collezione è unica nel mondo ceramico. La superficie di Blutech è priva del fastidioso movimento grafico "rigato" o "raggrumato" che caratterizza il gres porcellanato tecnico tradizionale. Blutech ha un aspetto di eccezionale eleganza, ulteriormente impreziosito da finiture superficiali esclusive. I pavimenti che si ottengono sono ideali per abitazioni private di lusso ed hotel di prestigio.

This collection's beauty is unparalleled in the world of ceramics. The Blutech surface lacks the annoying "striped" or "clotted" graphic movement that characterizes traditional technical porcelain stoneware. Blutech has an exceptionally elegant appearance, further enhanced by exclusive surface finishes. The floors obtained are perfect for luxury private residences and prestigious hotels.

COLORI E FORMATI

COLORS AND SIZES

Blutech viene proposta in sei eleganti colori sfumati tono su tono per una originale bellezza che va oltre la classica tinta unita. La collezione viene prodotta nello spessore maggiorato a 11mm e in tre formati rettificati e bisellati.

Blutech comes in six elegant tone-on-tone shades for an original beauty that goes beyond the classic solid colour. The collection is produced with an increased thickness of 11mm and in three rectified and bevelled formats.

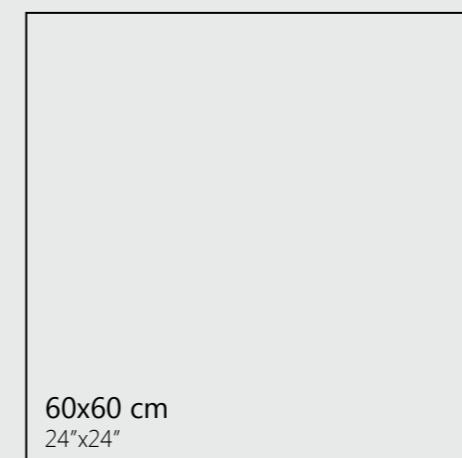
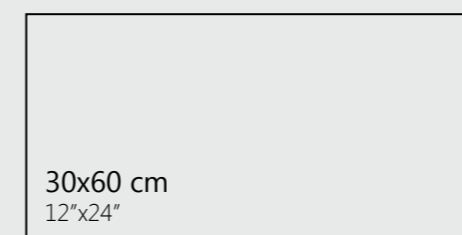
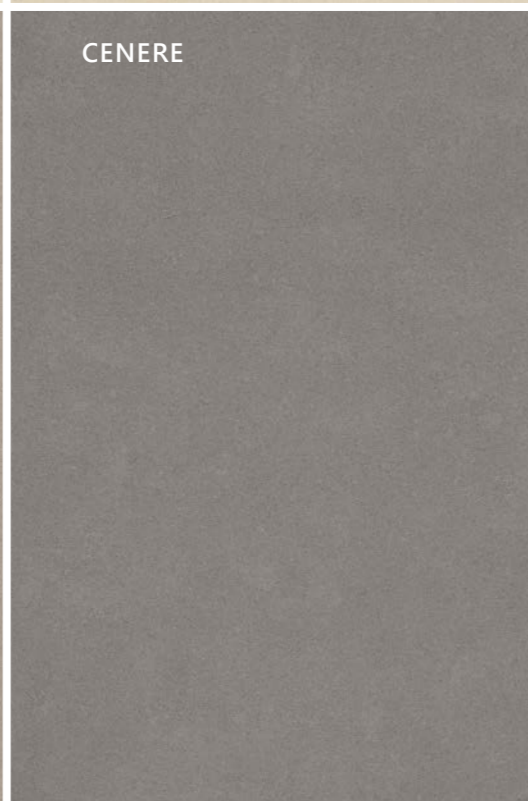
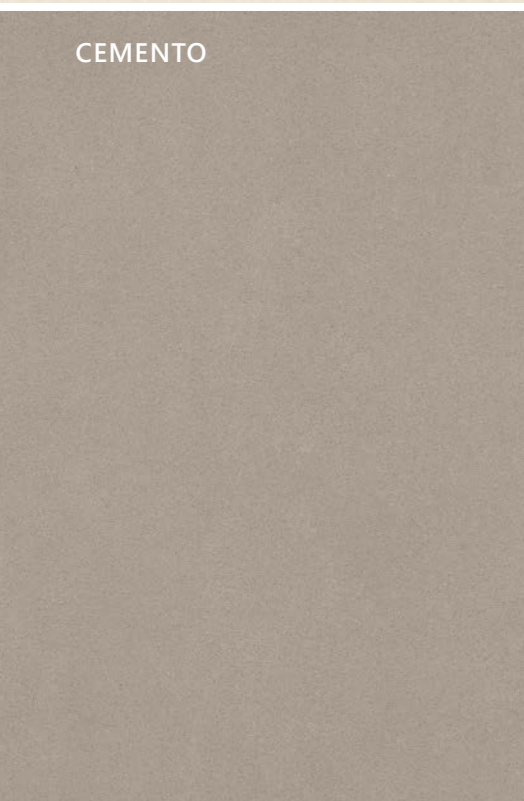

SUPERFICI SURFACES

NATURALE

SPESSORE / THICKNESS: **11mm**
FORMATI / SIZES: **cm 90x90 - 60x60 - 30x60**

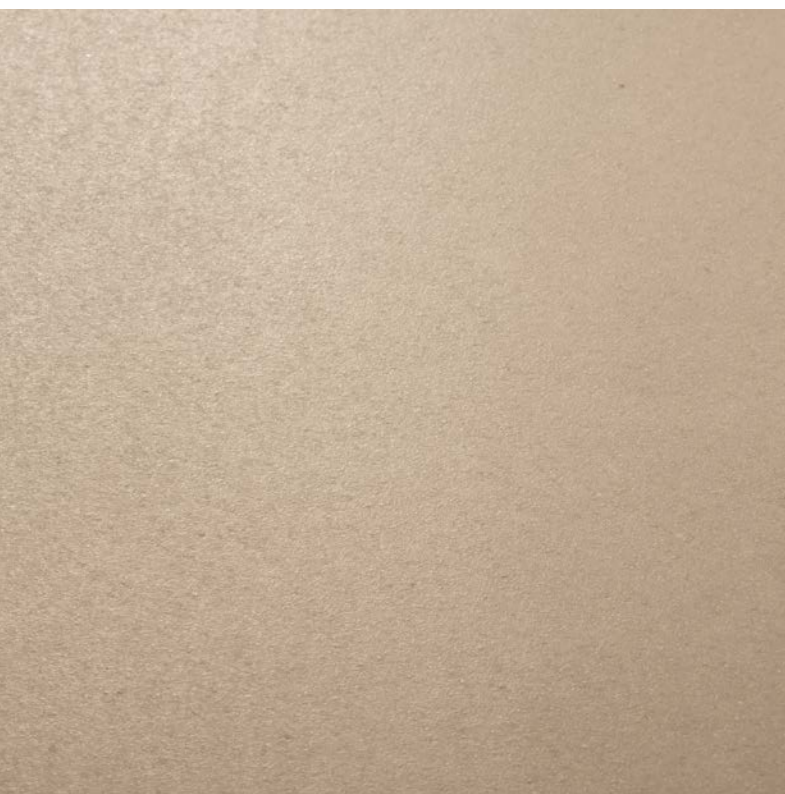

LAPPATA

SPESSORE / THICKNESS: **11mm**
FORMATI / SIZES: **cm 90x90 - 60x60 - 30x60**



PERLATA

SPESSORE / THICKNESS: **11mm**
FORMATI / SIZES: **cm 90x90 - 60x60 - 30x60**



LEVIGATA

SPESSORE / THICKNESS: **10,5mm**
FORMATI / SIZES: **cm 90x90 - 60x60 - 30x60**

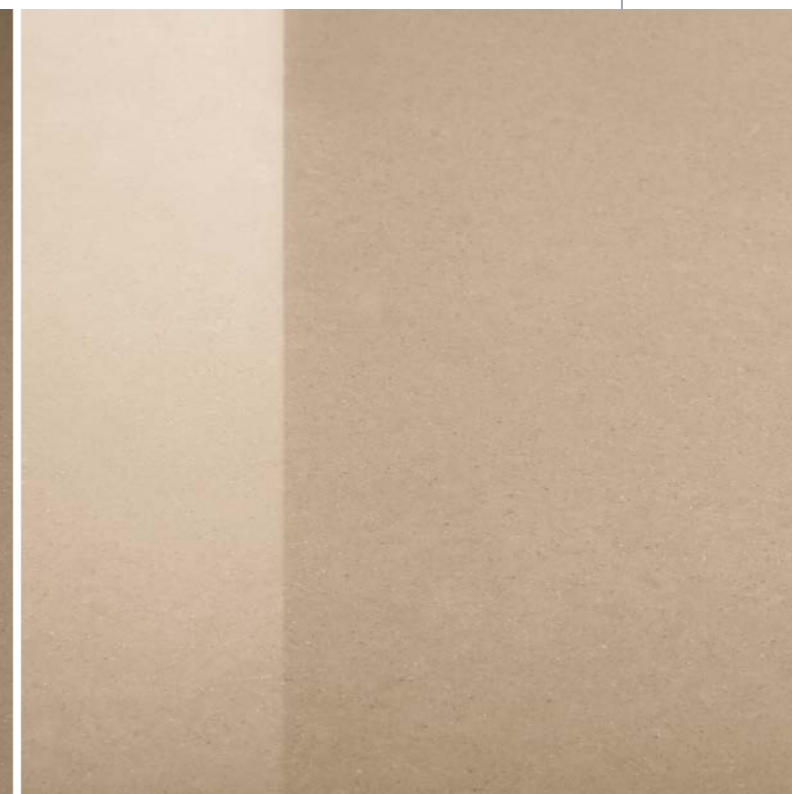

Blutech è disponibile in cinque finiture superficiali:

Naturale: opaca ed antiscivolo R10-B

Lappata: più morbida al tatto, semi lucida ed antiscivolo R9

Levigata: lucidata a specchio, luminosa e splendente

***Perlata:** levigata opaca dalla superficie morbida, preziosa e di straordinaria bellezza, unica al mondo

Juta: riproduce una elegante texture tessuto impressa a stampo, ideale per pavimentazioni antiscivolo R12 per suggestivi rivestimenti a parete.

Blutech is available in five surface finishes:

Naturale: opaque and anti-slip R10-B

Lappata: softer to the touch, semi-gloss, and anti-slip R9

Levigata: mirror polished, luminous, and resplendent

***Perlata:** matte polished with a soft, precious, and extraordinarily beautiful surface, like non other in the world

Juta: recreates an elegant printed fabric texture, perfect for anti-slip R12 flooring and for evocative wall cladding.

*Ideale per rivestimenti e consigliato per pavimenti solo in ambienti residenziali
Ideal for wall installation and recommended for floor installation in residential areas only

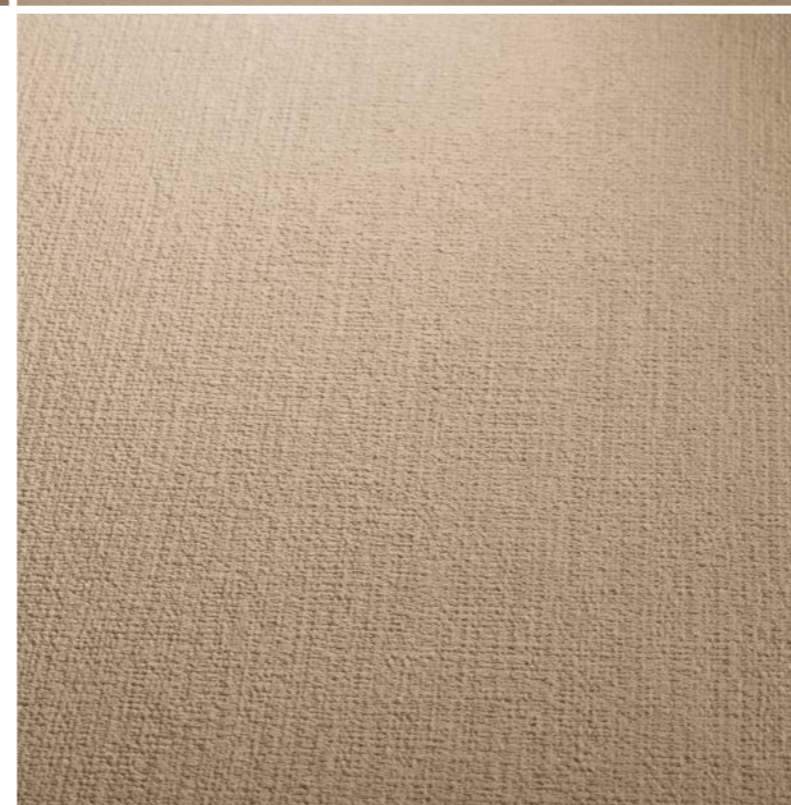

JUTA

SPESSORE / THICKNESS: **11mm**
FORMATO / SIZE: **cm 30x60**





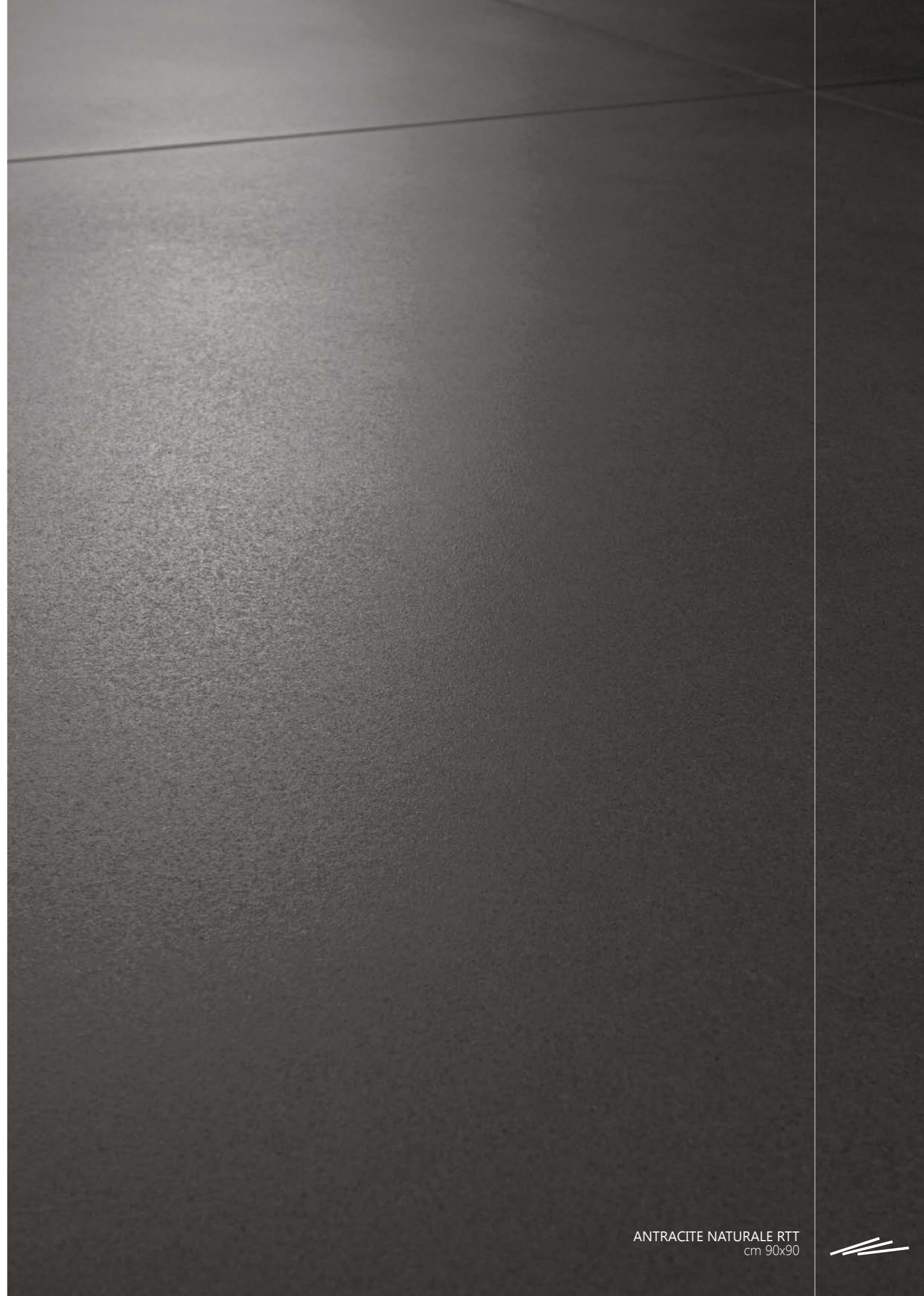

ANTRACITE NATURALE RTT
cm 90x90







ANTRACITE LEVIGATA RTT
cm 90x90





BIANCO LEVIGATA RTT
cm 90x90







RIVESTIMENTO/WALL: BIANCO JUTA RTT cm 30x60
PAVIMENTO/FLOOR: CENERE LAPPATA RTT cm 60x60





PAVIMENTO/FLOOR: CENERE LAPPATA RTT cm 60x60
RIVESTIMENTO/WALL: CENERE LAPPATA RTT cm 30x60 - BIANCO JUTA RTT cm 30x60









PAVIMENTO/FLOOR: Indoor: AVORIO PERLATA RTT cm 90x90 - Outdoor: AVORIO NATURALE RTT cm 90x90
RIVESTIMENTO/WALL: AVORIO JUTA RTT cm 30x60



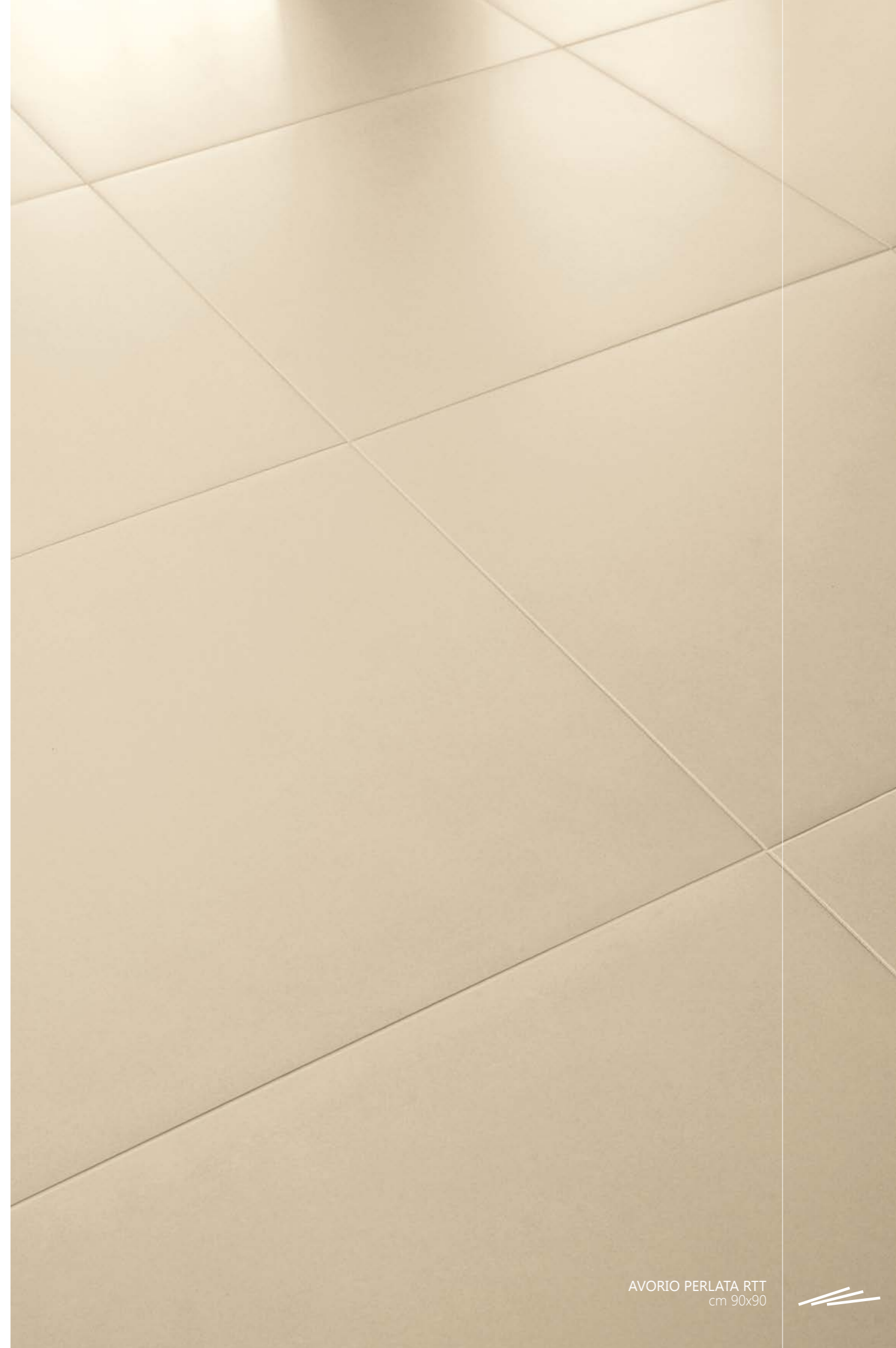
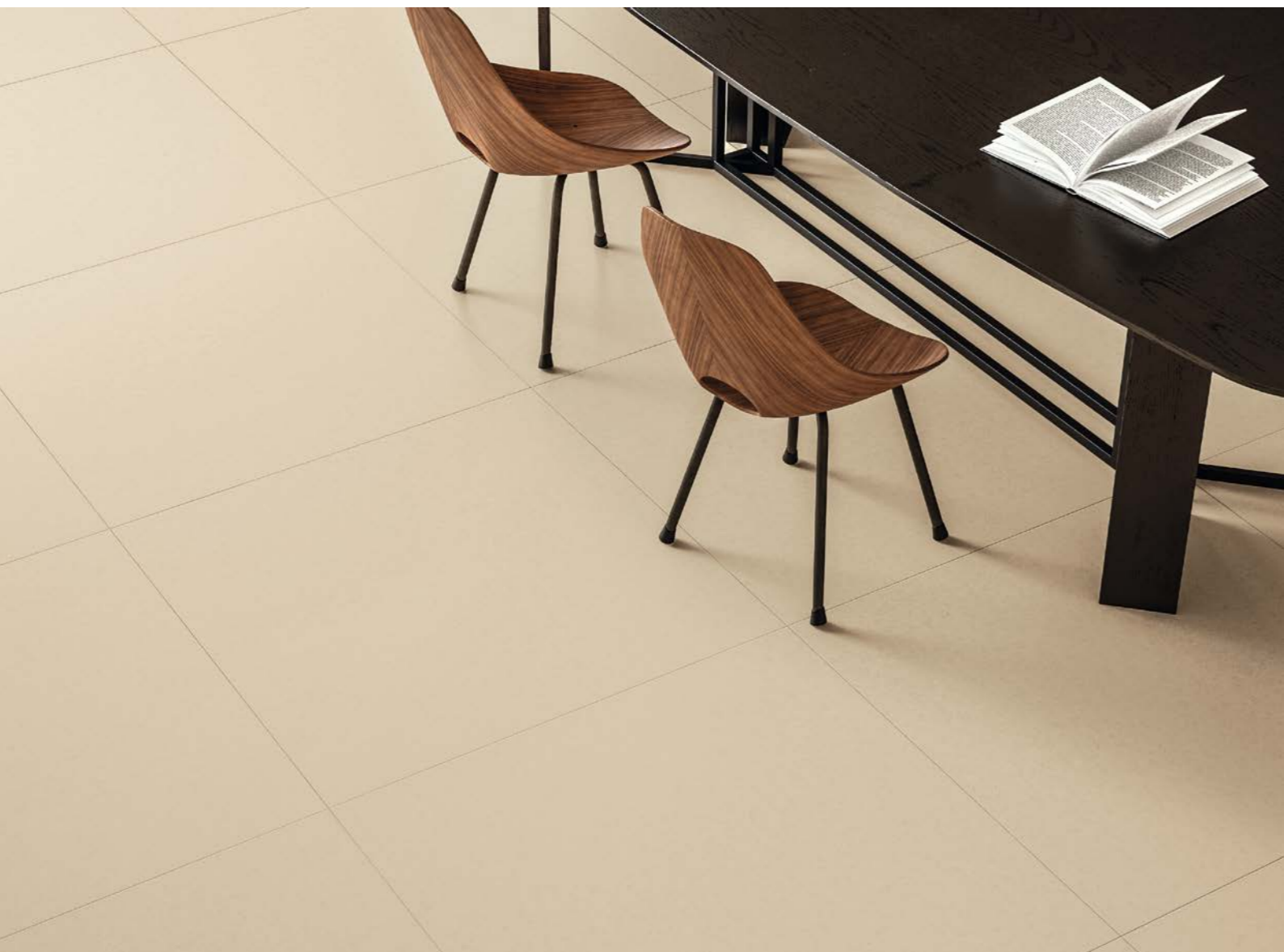

AVORIO PERLATA RTT
cm 90x90



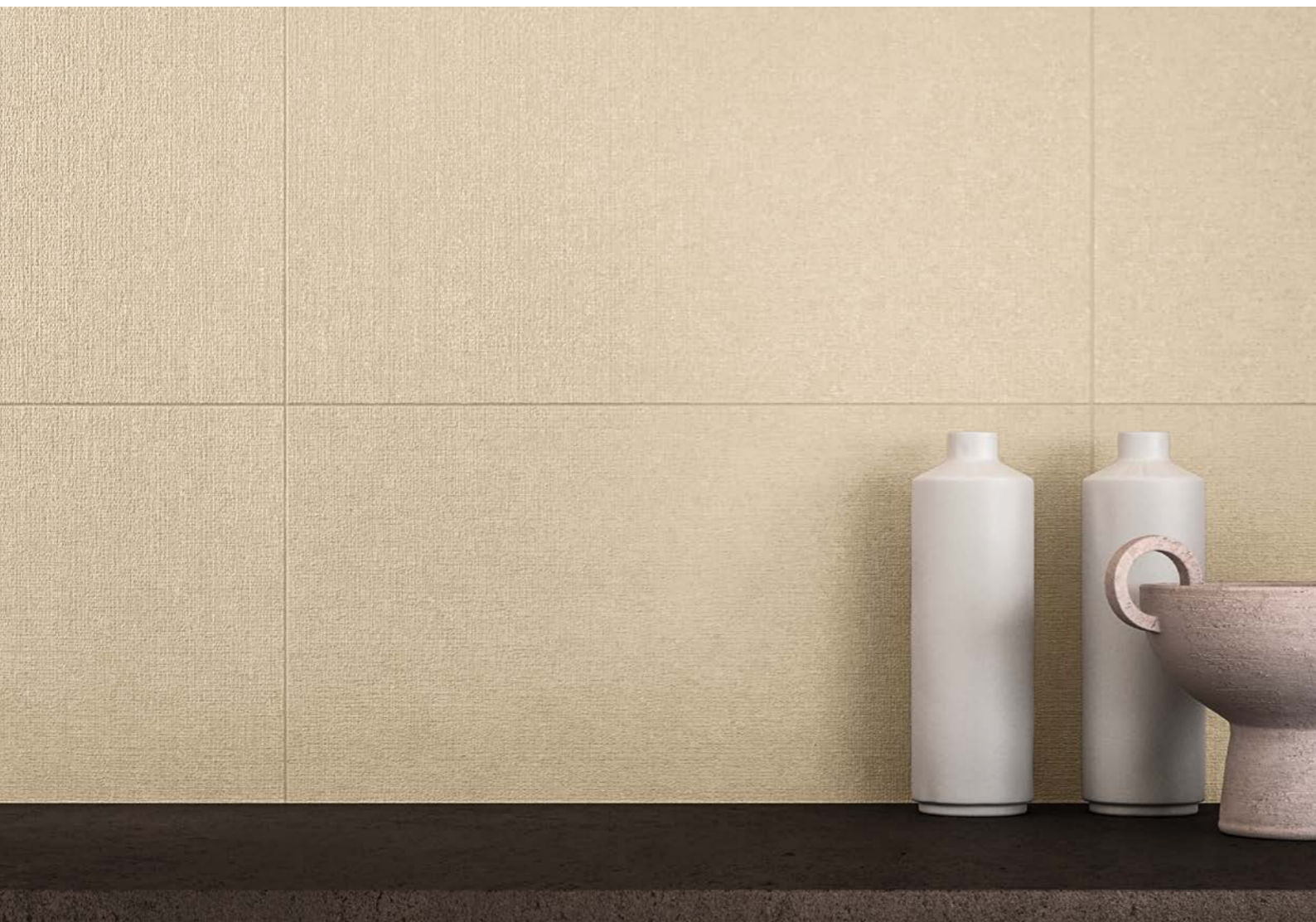

AVORIO JUTA RTT
cm 30x60



AVORIO NATURALE RTT
cm 90x90











BEIGE LAPPATA RTT
cm 90x90





BEIGE LAPPATA RTT
cm 90x90



TABELLE CALIBRI
SIZES TABLE

90x90 RTT	
CALIBRO CALIBRE	W*(mm)
O	901,0x901,0
P	898,0x898,0
Q	895,0x895,0

60x60 RTT	
CALIBRO CALIBRE	W*(mm)
R	595x595
T	599,8x599,8

30x60 RTT	
CALIBRO CALIBRE	W*(mm)
R	296,0x595,0
T	298,9x599,8

CARATTERISTICHE TECNICHE
TECHNICAL FEATURES

RESISTENZA ALLO SCIVOLAMENTO
SLIPPING RESISTANCE

DIN 51130	R12 JUTA- R10 NAT - R9 LAPP
DIN 51097	A+B+C JUTA - A+B NAT
BCR-TORTUS	μ > 0,74 JUTA - μ > 0,40 NAT
ANSI A326.3	DCOF ≥ 0.42 NAT, LAPP, JUTA
AS/NZS 4586	P4 JUTA - P3 NAT
BS 7976-2	PTV 36 + Wet (Slider 55) JUTA PTV 36 + Wet (Slider 96) NAT
UNE ENV 12633	Clase 3 JUTA - Clase 2 NAT - Clase 1 LAPP

CARICO DI ROTTURA (S) - Valore medio
BREAKING STRENGTH (S) - Average value

ISO 10545-4	400KG (3.920 N) 11MM 350KG (3.500 N) 10,5MM
ASTM C 648	900 lbf 11MM / 800 lbf 10,5MM

ASSORBIMENTO D'ACQUA
WATER ABSORPTION

ISO 10545-3 / ASTM C 373 **0,05%**

RESISTENZA ALLA FLESSIONE - Valore medio
MODULUS OF RUPTURE - Average value

ISO 10545-4 **50 N/mm²**

RESISTENZA ALL'ABRASIONE PROFONDA
DEEP ABRASION RESISTANCE

ISO 10545-6 / ASTM C 1243 **123 mm³**

DILATAZIONE TERMICA LINEARE
LINEAR THERMAL EXPANSION

ISO 10545-8 **α ≤ 7x10⁻⁶ °C⁻¹**
ASTM C 372 **α ≤ 4.4x10⁻⁶ °F⁻¹ / α ≤ 8x10⁻⁶ °C⁻¹**

RESISTENZA ALLE MACCHIE
STAIN RESISTANCE

ISO 10545-14 **5 RESISTENTE - RESISTANT NAT, LAPP, JUTA**
ASTM C 1378 **≥ 3 LEV, PERLATA**

RESISTENZA ALL'ATTACCO CHIMICO
RESISTANCE TO CHEMICAL ETCHING

ISO 10545-13 **LA-HA RESISTANT NAT, JUTA**
LB-HB RESISTANT LAPP, LEV, PERLATA
ASTM C 650 **A RESISTANT**

RESISTENZA AL GELO
FROST RESISTANCE

ISO 10545-12 / ASTM C 1026 **RESISTENTE - RESISTANT**

REAZIONE AL FUOCO
FIRE REACTION

EN 13823 **Classe/Class A1 (WALL)**
EN 9239-1 **Classe/Class A1 FL (FLOOR)**

FLAME SPREAD

ASTM E84 **Class A**

ROBINSON FLOOR TESTER

ASTM C 627 **≥ 14 cycles Extra heavy commercial**

CONDUCIBILITÀ TERMICA
THERMAL CONDUCTIVITY

EN 12524 **λ = 13 W/m °K / 0.7 Btu/ft h°F**

STONALIZZAZIONE
DESHADING

ANSI A137.1 **V2**

PULIBILITÀ
PULIBILITY

VISIBILITÀ DELLE IMPRONTE - Metodo Blustyle

Questa classificazione specifica il grado di visibilità delle impronte rilasciate sul pavimento dopo il passaggio con scarpe sporche di polvere.

A - Impronta non visibile
B - Impronta poco visibile
C - Impronta molto visibile. Ideale per rivestimenti e consigliato per pavimenti solo in ambienti residenziali.

TREAD MARK VISIBILITY - Blustyle method

This classification specifies the visibility degree of the tread marks left on the floor after walking with shoes dirty of dust.

A - Tread mark not visible
B - Tread mark not very visible.
C - Tread mark very visible. Ideal for wall installation and recommended for floor installation in residential areas only.

A LEVIGATA

B LAPPATA / NATURALE / JUTA

C PERLATA

FACILITÀ DI PULIZIA - Metodo Blustyle

Il metodo consiste nel classificare il grado di facilità nella rimozione dello sporco generico mediante pulizia manuale con detergente debole.

Grado 1 - Molto facile, nessuna resistenza dello sporco, rimozione immediata.
Grado 2 - Facile, leggera resistenza dello sporco, rimozione veloce.
Grado 3 - Meno facile, maggiore resistenza dello sporco, rimozione lenta. Si consiglia detergente forte. Ideale per rivestimenti e consigliato per pavimenti solo in ambienti residenziali.

CLEANING EASINESS - Blustyle method

The method consists in classifying the easiness grade in removing general dirt by manual cleaning with mild detergent.

Grade 1 - Very easy, no resistance of the dirt, immediate removal.
Grade 2 - Easy, light resistance of the dirt, fast removal.
Grade 3 - Less easy, higher resistance of the dirt, slow removal. A strong detergent is recommended. Ideal for wall installation and recommended for floor installation in residential areas only.

1 LEVIGATA

2 LAPPATA / NATURALE / JUTA

3 PERLATA

CERTIFICAZIONI
CERTIFICATIONS



EN 14411

Le DOP sono disponibili sul sito internet www.blustyle.it
DOP are available on the website www.blustyle.it



EMAS

GESTIONE AMBIENTALE
VERIFICATA
reg. n. PT-000097

Stabilimento Ilhavo/Aveiro
PORTUGAL



Blustyle Ceramica, tramite la holding Panariagroup Industrie Ceramiche S.p.A., è membro dello U.S. Green Building Council e del Green Building Council Italia.

Blustyle Ceramica, through Panariagroup Industrie Ceramiche S.p.A. holding, is a member of the U.S. Green Building Council and of the Italian Green Building Council.

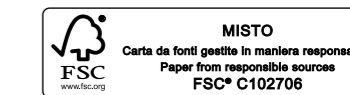

MISTO
Carta da fonti gestite in maniera responsabile
Paper from responsible sources
FSC® C102706

BLUTECH

UNIQUE ELEGANCE

GRES PORCELLANATO A TUTTA MASSA / FULL BODY PORCELAIN STONEWARE

B1a UGL - IMPASTO COLORATO / COLORED BODY

Conforme a /According to: ISO 13006-G (Gruppo/Group B1a), EN 14411-G (Gruppo/Group B1a), ANSI A137.1 (P1 Class)

COLORI / COLOURS



BIANCO

AVORIO

BEIGE

CEMENTO

CENERE

ANTRACITE

SPessori / THICKNESSES

11 mm Naturale, Lappata, Perlata, Juta / **10,5 mm** Levigata

Disponibile in **14mm** su richiesta, per lotti minimi di 8.000 mq.
Available in **14mm** on request for minimum order quantity of 8.000 Sqm

SUPERFICI E FINITURE / SURFACES AND FINISHING

NATURALE Rettificata e rompifilo / Rectified and chamfer

JUTA Rettificata e rompifilo / Rectified and chamfer

LAPPATA Lappata, rettificata e rompifilo / Honed, rectified and chamfer

LEVIGATA Levigata a specchio, rettificata e rompifilo / Mirror polished, rectified and chamfer

***PERLATA** Levigata opaca, rettificata e rompifilo / Matte polished, rectified and chamfer

*Ideale per rivestimenti e consigliato per pavimenti solo in ambienti residenziali / Ideal for wall installation and recommended for floor installation in residential areas only

FORMATI / SIZES

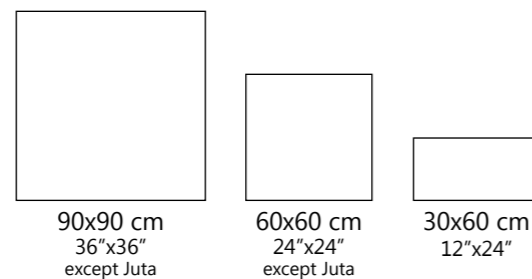

90x90 cm
36"x36"
except Juta

60x60 cm
24"x24"
except Juta

30x60 cm
12"x24"

PEZZI SPECIALI / SPECIAL PIECES

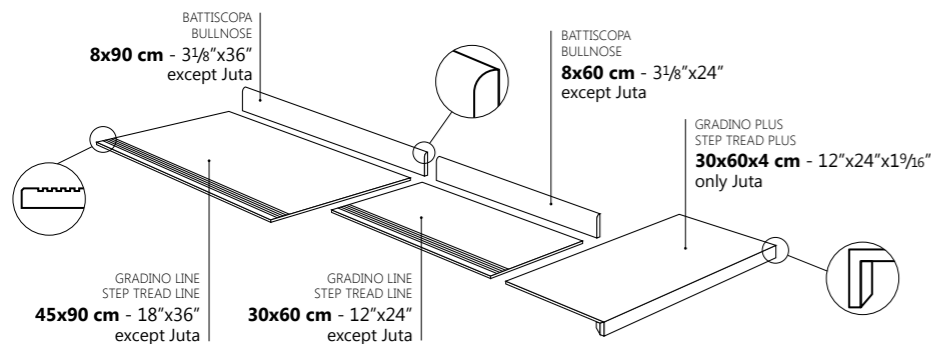

BATTISCOPA
BULLNOSE
8x90 cm - 3 1/8"x36"
except Juta

BATTISCOPA
BULLNOSE
8x60 cm - 3 1/8"x24"
except Juta

GRADINO PLUS
STEP TREAD PLUS
30x60x4 cm - 12"x24"x1 9/16"
only Juta

GRADINO LINE
STEP TREAD LINE
45x90 cm - 18"x36"
except Juta

GRADINO LINE
STEP TREAD LINE
30x60 cm - 12"x24"
except Juta

PEZZI SPECIALI CON SGUSCIO (DISPONIBILI SU RICHIESTA) SPECIAL COVE ELEMENTS (AVAILABLE UPON REQUEST)

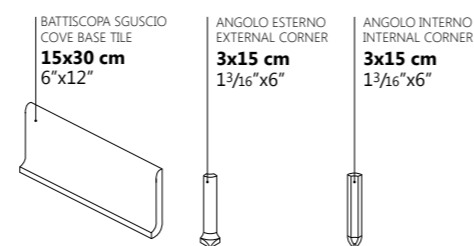

BATTISCOPA SGUSCIO
COVE BASE TILE
15x30 cm
6"x12"

ANGOLO ESTERNO
EXTERNAL CORNER
3x15 cm
1 3/16"x6"

ANGOLO INTERNO
INTERNAL CORNER
3x15 cm
1 3/16"x6"

GARANZIA / WARRANTY



RESIDENZIALE E PUBBLICO
RESIDENTIAL AND PUBLIC
NATURALE - LAPPATA - JUTA



RESIDENZIALE
RESIDENTIAL
PERLATA - LEVIGATA



GUARDA IL VIDEO / WATCH THE VIDEO

Blustyle | BELLA
PER
SEMPRE
by COTTO D'ESTE

Blustyle[®] | BELLA
by COTTO D'ESTE | PER
SEMPRE

Via Emilia Romagna, 31 - 41049 Sassuolo (MO) Italy
ph. +39 0536 814911 - fax +39 0536 814921
blustyle.it - info@blustyleceramica.it

PANARIAGROUP INDUSTRIE CERAMICHE S.p.A.