

BUSE DE Puits PERFOREE A EMB.

Ø Int. 1,00 m - Ht. 0,60 m

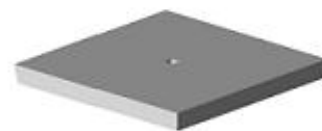
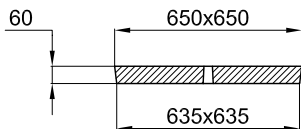

COUVERCLE BUSE DE Puits Ø 1,00 m AVEC TAMPON - RENFORCES

Code Article : 461150

Poids : 211 Kg

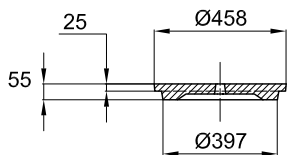
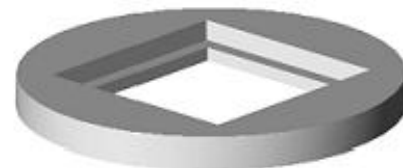
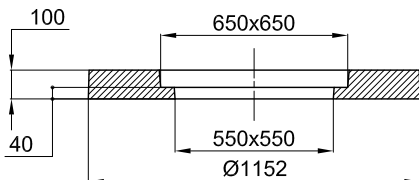

COUVERCLE BUSE DE Puits Ø 1,00 m AVEC TAMPON

Code Article : 461110

Poids : 130 Kg

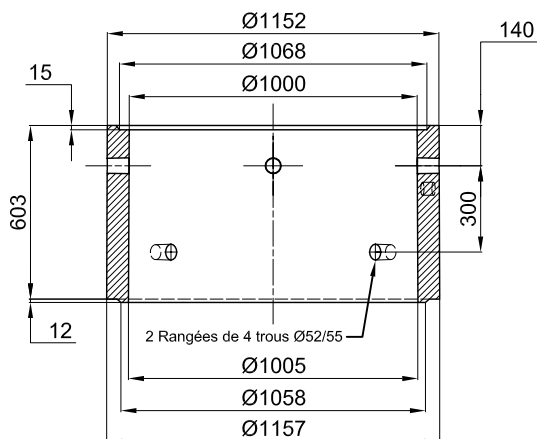
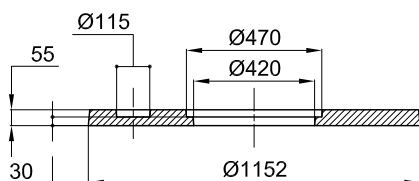

BUSE DE Puits A EMBLEMENTS Ø Int. 1,00 m Ht. 0,60 m - PERFOREE

Code Article : 460030

Poids : 360 Kg

2 Trous de manutention Ø45 prof. 40



S.A. R.THEBAULT

Siège social et usine : ZI de Saint-Eloi - Plouédern - 29800 LANDERNEAU

Tél. 02 98 21 63 63 - Fax : 02 98 21 34 11

Usines à : Mauron (56430) et Verneuil S/Avre (27130)