

Blustyle
by COTTO D'ESTE

CONCRETE JUNGLE
ENJOY THE CITY



Blustyle[®] | BELLA
PER
SEMPRE
by COTTO D'ESTE

A photograph of a cable-stayed bridge at sunset. The bridge's dark silhouette is set against a sky filled with large, golden-hued clouds. The water in the foreground is dark and textured. The text 'CONCRETE JUNGLE' is written in a large, bold, white sans-serif font, with 'ENJOY THE CITY' in a smaller, white sans-serif font directly below it.

CONCRETE JUNGLE
ENJOY THE CITY

ATELIER·25

FACTORY·56

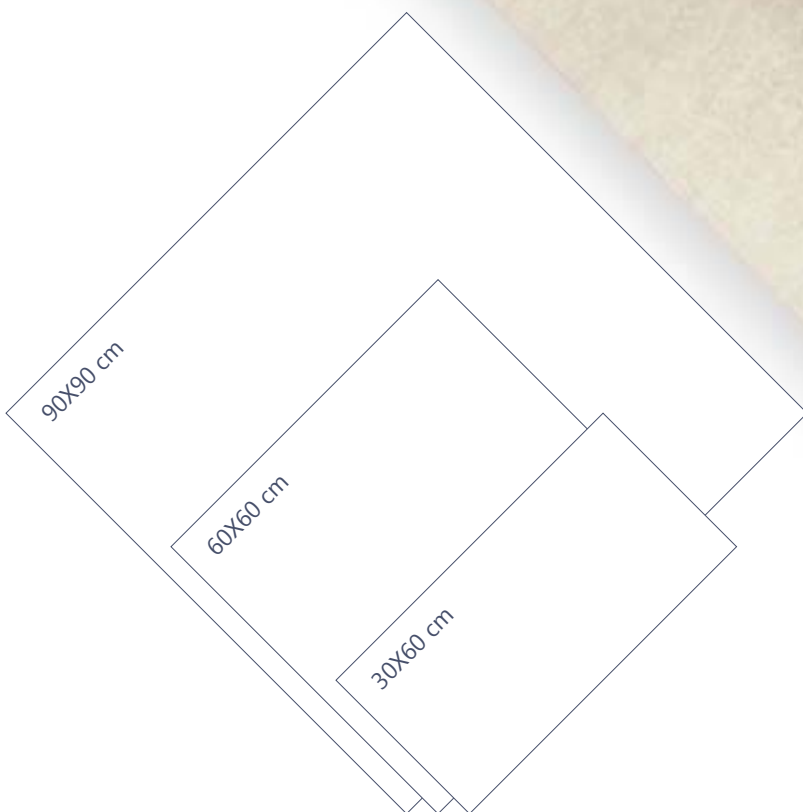

STORE·18

PUB·49

NATURAL

HONED

COLOURS AND SIZES





NATURAL

HONED

Con il cemento è nata la città moderna poiché con esso ogni tipo di costruzione è diventata possibile. Grazie al suo utilizzo oggi viviamo in spazi più grandi e sicuri.

Le grandi opere contemporanee, da Le Corbusier fino agli architetti dei giorni nostri, sono realizzate grazie a questa importante materia duttile e resistente.

Da un'intensa ricerca tra gli spazi industriali che ci circondano è nata la serie CONCRETE JUNGLE, un gres porcellanato versatile dalle tonalità essenziali proprie del cemento urbano.

Un prodotto tecnico e di grande effetto, caratterizzato da un'originale grafica e da due affascinanti finiture dal mood contemporaneo e di design perfette per ogni ambiente.

Modern cities come from concrete because it has made any kind of building possible. Thanks to its use, we live in larger and safer places.

Great contemporary architecture, from the works of Le Corbusier to those of the architects of today, has been created using this adaptable and resistant material.

Following extensive research on the industrial spaces that surround us, we have created the CONCRETE JUNGLE series, versatile porcelain stoneware with the essential tones of urban concrete.

A technical product with a great appeal, characterised by original patterns and by two particularly attractive finishes offering a truly contemporary mood that is ideal for any environment.







ATELIER-25 Natural
cm 60X60





ATELIER-25 Natural
cm 90X90



ATELIER-25 Honed
cm 60X60







The
COLOURS
beautyshop

the
COLOURS
beautyshop

FACTORY-56 Natural
cm 60X60







FACTORY·56 Honed
cm 60X60







STORE.18 Natural
cm 90X90





STORE:18 Natural
cm 90X90



31
WED VII







PUB-49 Honed
cm 60X60







PUB-49 Natural
cm 60X60



SCHEMI DI POSA
LAYING SOLUTIONS

MODULO "A"
"A" MODULE

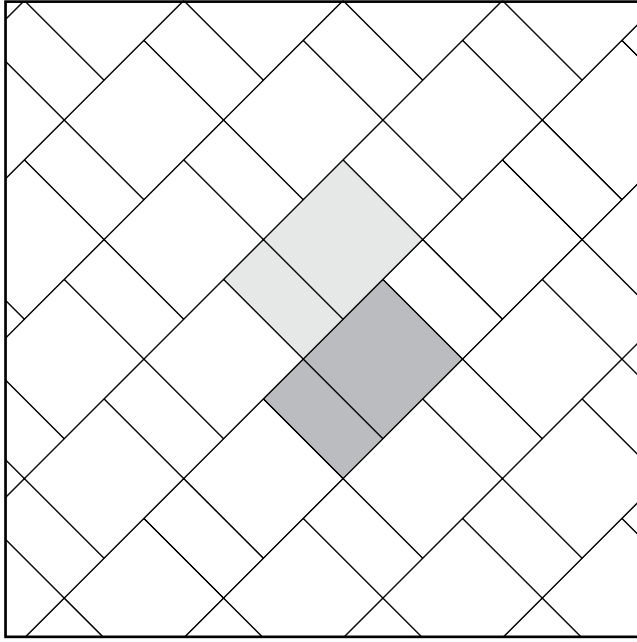

cm 60x60 (1 pz/pcs)	67%
cm 30x60 (1 pz/pcs)	33%

MODULO "B"
"B" MODULE

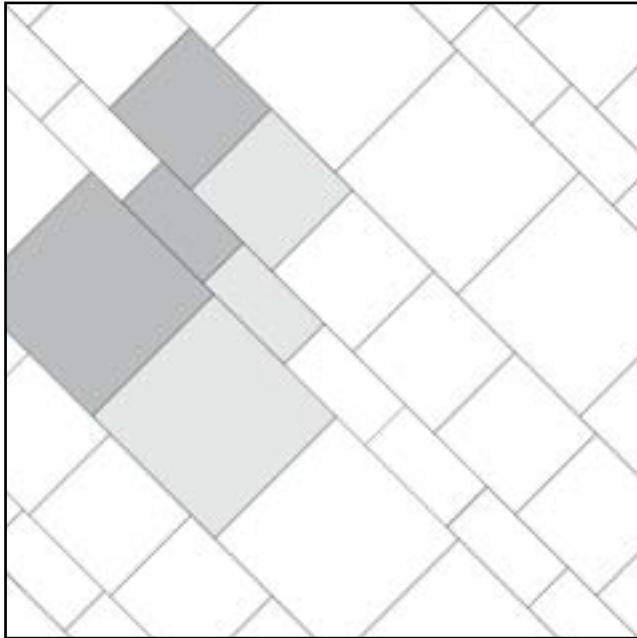

cm 90x90 (1 pz/pcs)	60%
cm 60x60 (1 pz/pcs)	27%
cm 30x60 (1 pz/pcs)	13%

TABELLE CALIBRI
SIZE TABLES

90x90 RETT.	
CALIBRO CALIBRE	W*(mm)
O	901,0x901,0
P	898,0x898,0
Q	895,0x895,0

60x60 RETT.	
CALIBRO CALIBRE	W*(mm)
O	600,0x600,0
P	598,0x598,0
Q	596,0x596,0
R	595,0x595,0

30x60 RETT.	
CALIBRO CALIBRE	W*(mm)
O	299,0x600,0
P	298,0x598,0
Q	297,0x596,0
R	296,0x595,0



CARATTERISTICHE TECNICHE TECHNICAL FEATURES

RESISTENZA ALLO SCIVOLAMENTO SLIPPERING RESISTANCE

DIN 51130	R10 NATURAL - R9 HONED
DIN 51097	B (A+B) NATURAL
BCR-TORTUS	$\mu > 0,40$
ANSI A137.1 BOT 3000	DCOF $\geq 0,42$
UNE ENV 12633 Pendulum	CLASE 1 NATURAL

CARICO DI ROTTURA (S) - Valore medio BREAKING STRENGTH (S) - Average value

ISO 10545-4	$\geq 220 \text{ kg}$ ($\geq 2150 \text{ N}$) 10 mm $\geq 310 \text{ kg}$ ($\geq 3040 \text{ N}$) 11 mm
ASTM C 648	$\geq 450 \text{ lbf}$ 10 mm - $\geq 650 \text{ lbf}$ 11 mm

RESISTENZA ALLA FLESSIONE - Valore medio BENDING STRENGTH - Average value

ISO 10545-4	$\geq 510 \text{ kg/cm}^2$ ($\geq 50 \text{ N/mm}^2$)
-------------	---

RESISTENZA ALL'ABRASIONE PROFONDA - Valore medio DEEP ABRASION RESISTANCE - Average value

ISO 10545-6	$\leq 145 \text{ mm}^3$
-------------	-------------------------

RESISTENZA ALLE MACCHIE STAIN RESISTANCE

ISO 10545-14	CLASSE 5
--------------	----------

RESISTENZA ALL'ATTACCO CHIMICO RESISTANCE TO CHEMICAL ETCHING

ISO 10545-13	ULA-UHA <small>No acido fluoridrico e derivati Not resistant to hydrofluoric acid and derivatives</small>
--------------	---

ASSORBIMENTO D'ACQUA WATER ABSORPTION

ISO 10545-3	$\leq 0,1\%$
-------------	--------------

RESISTENZA AL GELO FROST RESISTANCE

ISO 10545-12	INGELIVO - FROST PROOF
--------------	------------------------

STONALIZZAZIONE DESHADING

ANSI A137.1	V3
-------------	----

PULIBILITÀ PULIBILITY

VISIBILITÀ DELLE IMPRONTE - Metodo Blustyle

Questa classificazione specifica il grado di visibilità delle impronte rilasciate sul pavimento dopo il passaggio con scarpe sporche di polvere.

- A - Impronta non visibile
- B - Impronta poco visibile
- C - Impronta molto visibile. Ideale per rivestimenti e consigliato per pavimenti solo in ambienti residenziali.

TREAD MARK VISIBILITY - Blustyle method

This classification specifies the visibility degree of the tread marks left on the floor after walking with shoes dirty of dust.

- A - Tread mark not visible
- B - Tread mark not very visible.
- C - Tread mark very visible. Ideal for wall installation and recommended for floor installation in residential areas only.

B

FACILITÀ DI PULIZIA - Metodo Blustyle

Il metodo consiste nel classificare il grado di facilità nella rimozione dello sporco generico mediante pulizia manuale con detergente debole.

- Grado 1 - Molto facile, nessuna resistenza dello sporco, rimozione immediata.
- Grado 2 - Facile, leggera resistenza dello sporco, rimozione veloce.
- Grado 3 - Meno facile, maggiore resistenza dello sporco, rimozione lenta. Si consiglia detergente forte. Ideale per rivestimenti e consigliato per pavimenti solo in ambienti residenziali.

CLEANING EASINESS - Blustyle method

The method consists in classifying the easiness grade in removing general dirt by manual cleaning with mild detergent.

- Grade 1 - Very easy, no resistance of the dirt, immediate removal.
- Grade 2 - Easy, light resistance of the dirt, fast removal.
- Grade 3 - Less easy, higher resistance of the dirt, slow removal. A strong detergent is recommended. Ideal for wall installation and recommended for floor installation in residential areas only.

2

CERTIFICAZIONI CERTIFICATIONS



EN 14411

Le DOP sono disponibili sul sito internet www.blustyle.it
DOP are available on the website www.blustyle.it



Sistema di gestione della qualità siti produttivi
Quality management system of production sites



Sistema di gestione ambientale siti produttivi
Environmental management system of production sites



EMAS
GESTIONE AMBIENTALE VERIFICATA
reg. n. I-000309
STABILIMENTO DI FINALE EMILIA (MO)



EMAS
GESTIONE AMBIENTALE VERIFICATA
reg. n. I-000239
STABILIMENTO DI TOANO (RE)



Blustyle, tramite la holding Panariagroup Industrie Ceramiche S.p.A., è membro dello U.S. Green Building Council e del Green Building Council Italia.



Blustyle, through Panariagroup Industrie Ceramiche S.p.A. holding, is a member of the U.S.Green Building Council and of the Italian Green Building Council.

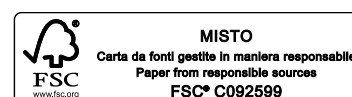
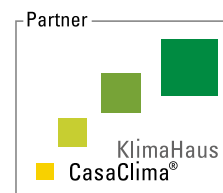

CONCRETE JUNGLE

ENJOY THE CITY

GRES PORCELLANATO / PORCELAIN STONEWARE

B1a UGL - IMPASTO COLORATO/COLORED BODY - Decorazione/Decoration: INKJET - EFFETTO 3D/INKJET - 3D EFFECT

Conforme/In compliance with: ISO 13006-G, EN 14411-G, ANSI A137.1

COLORI / COLOURS



ATELIER-25



FACTORY-56



STORE-18



PUB-49

SPESSORE / THICKNESS

10 mm - 11 mm (90x90 cm)

SUPERFICI E FINITURE / SURFACES AND FINISHING

NATURAL RETTIFICATA E ROMPIFILO / RECTIFIED AND CHAMFER

HONED LAPPATA, RETTIFICATA E ROMPIFILO / HONED, RECTIFIED AND CHAMFER

FUGA (DIMENSIONE DISTANZIATORE) - JOINT (SPACER SIZE)

≥ 2 mm

È compito del posatore controllare sempre il materiale prima della posa. Stendere a terra alcune piastrelle (circa 3 mq.) e verificarne accuratamente le specifiche tecniche ed estetiche d'insieme. The person in charge of installation must check all material before installing it. Place some tiles on the floor (approx. 3 m²) and check the overall technical and aesthetic characteristics with particular care.

FORMATI / SIZES

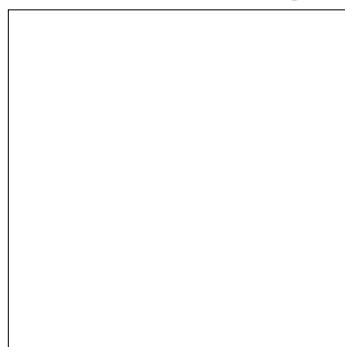

90X90 cm
36"x36"

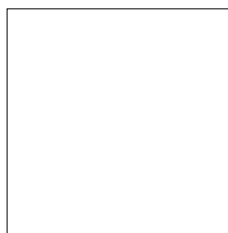

60X60 cm
24"x24"



30X60 cm
12"x24"

PEZZI SPECIALI / SPECIAL PIECES

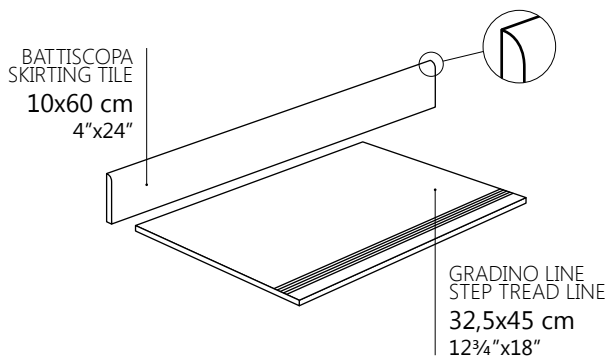

GARANZIA / WARRANTY



20 ANNI RESIDENZIALE E PUBBLICO
20 YEARS RESIDENTIAL AND PUBLIC

Blustyle[®] | BELLA
PER
SEMPRE
by COTTO D'ESTE 

Blustyle[®] | BELLA
by COTTO D'ESTE | PER
SEMPRE

Via Emilia Romagna, 31 - 41049 Sassuolo (MO) Italy
ph. +39 0536 814911 - fax +39 0536 814921
blustyle.it - info@blustyle.it

PANARIAGROUP INDUSTRIE CERAMICHE S.p.A.

EDITION: July 2016