

# BOITE PLUVIALE 40x40 Ext. 33x33 Int. H : 35 cm

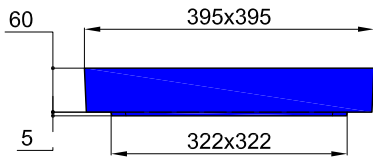

**COUVERCLE RENFORCE Ep : 6 cm  
POUR BOITE PLUVIALE 40x40 Ext.**

**Code Article : 240312  
Poids : 23 Kg**

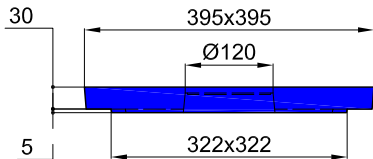
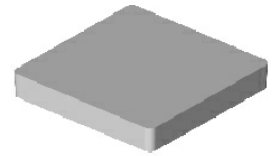

**COUVERCLE ARME  
POUR BOITE PLUVIALE 40x40 Ext.**

**Code Article : 240310  
Poids : 10 Kg**

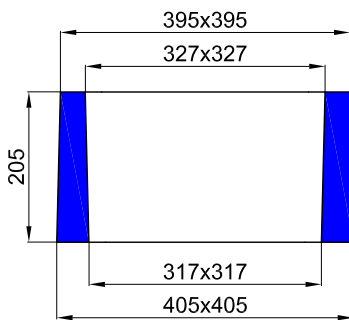
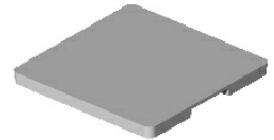

**REHAUSSE H : 20  
POUR BOITE PLUVIALE 40x40 Ext.**

**Code Article : 240320  
Poids : 29 Kg**

**Conditionnement : 30 / palette**

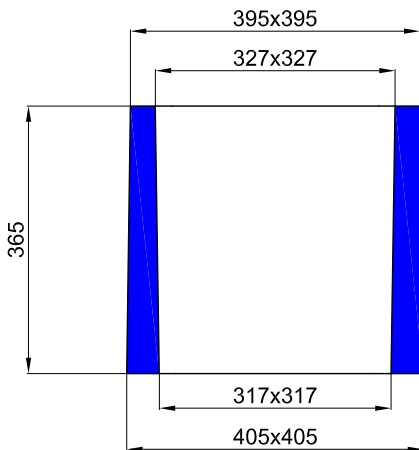

**REHAUSSE H : 35  
POUR BOITE PLUVIALE 40x40 Ext.**

**Code Article : 240330  
Poids : 43 Kg**

**Conditionnement : 18 / palette**

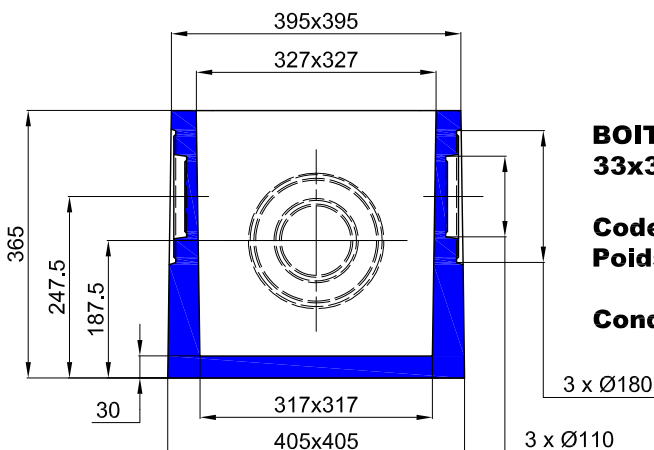
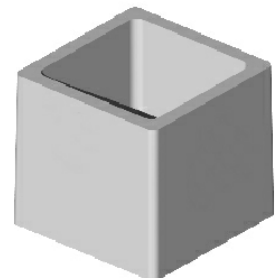

**BOITE PLUVIALE 40x40 Ext.  
33x33 Int. H : 35**

**Code Article : 240305  
Poids : 50 Kg**

**Conditionnement : 18 / palette**

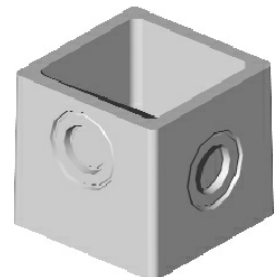

**S.A. R.THEBAULT**

Siège social et usine : ZI de Saint-Eloi - Plouédern - 29800 LANDERNEAU

Tél. 02 98 21 63 63 - Fax : 02 98 21 34 11

Usines à : Maoron (56430) et Verneuil S/Avre (27130)