

TAURUS COLOR

CZ TAURUS COLOR – harmonie bez limitů

Vysoce slinuté neglazované jednobarevné dlaždice série Taurus COLOR ve formátech 5x5 cm, 10x10 cm, 20x20 cm, 30x30 cm a 60x60 cm barevně harmonizují s nočními barvami sérií ColorONE a ColorTWO. Barevná synergie jednotlivých sérií přispívá k vytvoření esteticky zajímavého prostoru při zachování vysokých nároků na užité vlastnosti. Pro reprezentativní a luxusní prostory lze navíc doporučit leštěný povrch. Důležitou součástí nabídky jsou funkční doplňky pro standardní i náročnější řešení.

EN TAURUS COLOR – harmony without limits

Fully vitrified unglazed uni-coloured tiles of the Taurus COLOR in the formats 5x5 cm, 10x10 cm, 20x20 cm, 30x30 cm and 60x60 cm harmonise with the night colours of series ColorONE and ColorTWO. The colour synergy of individual series contributes to creation of an interesting space while the high demands for utility properties are maintained. In addition, a polished surface is available to create a luxurious finish. An important part of the offer includes functional special pieces for both standard and demanding solutions.

PL TAURUS COLOR – harmonia bez ograniczeń

Wysokospiekane nieszkliwione jednobarwne płytki gresowe serii Taurus COLOR w formatach 5x5 cm, 10x10 cm, 20x20 cm, 30x30 cm i 60x60 cm, kolorystycznie harmonizują z nocnymi barwami serii ColorONE i ColorTWO. Barwna synergie poszczególnych serii pozwala wytworzyć estetyczną, ciekawą przestrzeń przy zachowaniu wysokich walorów użytkowych. Do pomieszczeń reprezentacyjnych i luksusowych można zaproponować płytki z powierzchnią polerowaną. Ważnym elementem serii są kształtki o różnej funkcjonalności.

RUS TAURUS COLOR – гармония без ограничений

Высокоспекаемая неглазурованная одноцветная плитка серии Taurus COLOR в формате 5x5 см, 10x10 см, 20x20 см, 30x30 см и 60x60 см, по цвету гармонирующая с холодными цветами серии ColorONE и ColorTWO. Цветовое решение серии способствует созданию эстетически интересного пространства при сохранении высоких требований к полезным свойствам. Для придания роскоши в отделке в наличии также имеется полированная поверхность. Важной составной частью предложения являются функциональные аксессуары для стандартных и более сложных решений.

HU TAURUS COLOR – határok nélküli harmónia

A Taurus COLOR program homogén színű mázatlan gres termékei 5x5 cm, 10x10 cm, 20x20 cm, 30x30 cm és 60x60 cm-es méretben összhangban van a ColorONE és ColorTWO termékcsalád színeivel. A rendelkezésre álló színválaszték segítségével lehetőségünk van teljesen egyedi stílusú burkolatot létrehozni anélkül, hogy le kellene mondanunk a minőség iránti igényünkről. A polírozott felületekkel pedig igazi luxus megjelenést biztosíthatunk a burkolandó helységnek. A program fontos részét képezi a különböző kiegészítő elemek választéka.

ES TAURUS COLOR – armonía sin límites

Baldosas sin esmaltar altamente vitrificadas de la serie Taurus COLOR en formatos de 5x5 cm, 10x10 cm, 20x20 cm, 30x30 cm y 60x60 coinciden con los colores nocturnos de las series ColorONE y ColorTWO. Estas sinergias entre las series y sus colores permiten crear espacios con alto valor estético manteniendo altas exigencias técnicas y pro propiedades para zonas públicas. Para los espacios de con más alto nivel se recomienda el uso de la superficie pulida. Una parte importante de la oferta son accesorios técnicos y funcionales para ofrecer soluciones estándares o las más exigentes.

TAURUS COLOR



EN 14411:2012, annex G Bla UGL

cm		mm		Wyrábek Product	Povrch Surface	Protiskliznosť Slip resistance koeficient tření - za sucha	19	07	06	11	10	30
cm	mm	cm	mm				Black	Dark Grey	Light Grey	Extra White	Super White	MoCCA
	5x5	48x48x9		mozaika set 30x30 cm mosaic sheet 30x30 cm	S	R10/B $\mu \geq 0,7$	TDM06019 68 set	TDM06007 68 set	TDM06006 68 set	TDM06011* 68 set	TDM06010 68 set	TDM06030 68 set
	10x10	98x98x9		dlaždice floor tile	S	R10/B $\mu \geq 0,7$	TAA12019 88 m ²	TAA12007* 86 m ²	TAA12006 86 m ²	TAA12011* 92 m ²	TAA12010 86 m ²	TAA12030* 86 m ²
	20x20	198x198x9		dlaždice floor tile	S	R10/A $\mu \geq 0,6$	TAA26019 82 m ²	TAA26007 80 m ²	TAA26006 80 m ²		TAA26010 80 m ²	TAA26030 80 m ²
	30x30	298x298x9		dlaždice floor tile	S	R9/A $\mu \geq 0,6$	TAA35019 82 m ²	TAA35007 78 m ²	TAA35006 78 m ²	TAA35011* 86 m ²	TAA35010 78 m ²	TAA35030 78 m ²
		295x295x8			SL	$\mu \geq 0,5$	TAL35019* 90 m ²	TAL35007* 88 m ²	TAL35006* 88 m ²		TAL35010* 88 m ²	TAL35030* 88 m ²
	60x60	598x598x10		dlaždice floor tile	S	R9/A $\mu \geq 0,6$	TAA61019 88 m ²	TAA61007 88 m ²	TAA61006 88 m ²		TAA61010 88 m ²	TAA61030 88 m ²
	30x30	298x298x9		schodovka step tile	S	R10/A $\mu \geq 0,6$	TCP35019* 46 ks	TCP35007* 46 ks	TCP35006* 46 ks	TCP35011* 48 ks	TCP35010* 46 ks	TCP35030* 46 ks
	60x9,5	598x95x10		sokl skirting plinth	S		TSAS4019 52 ks	TSAS40007 52 ks	TSAS4006 52 ks		TSAS4010 52 ks	TSAS4030 52 ks
	30x8	298x80x9		sokl skirting plinth	S		TSAJB019 28 ks	TSAJB007* 28 ks	TSAJB006* 28 ks	TSAJB011* 28 ks	TSAJB010* 28 ks	TSAJB030* 28 ks
	20x9	198x90x9		sokl s pořížbkem cove skirting	S		TSPEM019* 32 ks	TSPEM007* 32 ks	TSPEM006* 32 ks		TSPEM010* 32 ks	TSPEM030* 32 ks
	2,3x9	23x90x10		sokl vnitřní roh cove skirting inside corner	S		TSIRB019* 48 ks	TSIRB007* 48 ks	TSIRB006* 48 ks		TSIRB010* 48 ks	TSIRB030* 48 ks
	2,3x9	23x90x7		sokl vnější roh cove skirting outside corner	S		TSERB019* 48 ks	TSERB007* 48 ks	TSERB006* 48 ks		TSERB010* 48 ks	TSERB030* 48 ks
	30x8	298x80x9		sokl s pořížbkem cove skirting	S		TSPJB019* 34 ks	TSPJB007* 34 ks	TSPJB006* 34 ks		TSPJB010* 34 ks	TSPJB030* 34 ks
	2,3x8	23x80x10		sokl vnitřní roh cove skirting inside corner	S		TSIRH019* 48 ks	TSIRH007* 48 ks	TSIRH006* 48 ks		TSIRH010* 48 ks	TSIRH030* 48 ks
	2,3x8	23x80x7		sokl vnější roh cove skirting outside corner	S		TSERH019* 48 ks	TSERH007* 48 ks	TSERH006* 48 ks		TSERH010* 48 ks	TSERH030* 48 ks
	10x10	98x98x8		bezbariérová tvarovka rohová shower piece corner	SB	R10/B $\mu \geq 0,7$	TTR12019 54 ks	TTR12007 54 ks	TTR12006 54 ks		TTR12010 54 ks	TTR12030 54 ks
	10x10	98x98x8		bezbariérová tvarovka průběžná shower piece continuous	SB	R10/B $\mu \geq 0,7$	TTP12019 54 ks	TTP12007 54 ks	TTP12006 54 ks		TTP12010 54 ks	TTP12030 54 ks

* Výroba na objednávku | Production by order | Produkcja na zamówienie | Производство под заказ | Gyártás rendelésre | Producción bajo demanda

S - Standardní povrch | Standard surface | Standartowa powierzchnia | Стандартная поверхность | Sima felület | Superficie estándar
 SL - Leštěný povrch | Polished surface | Powierzchnia polerowana | Полированная поверхность | Polírozott felület | Superficie pulida

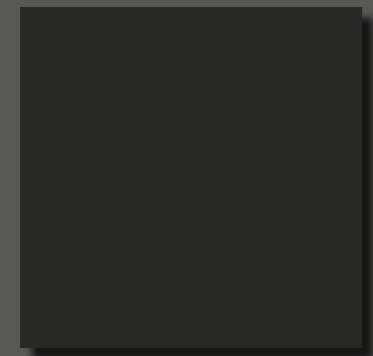
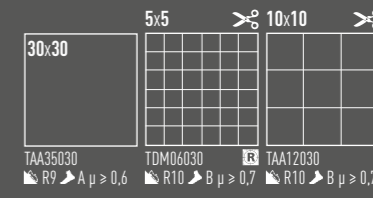
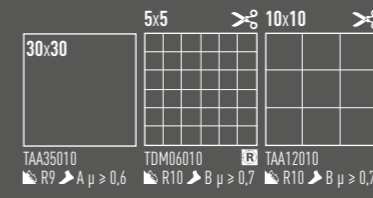
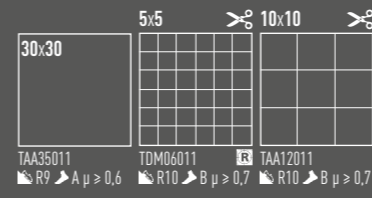
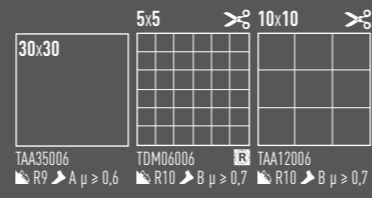
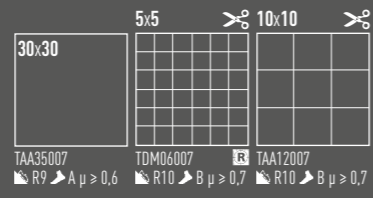
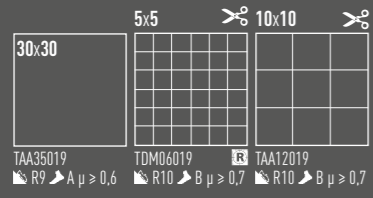
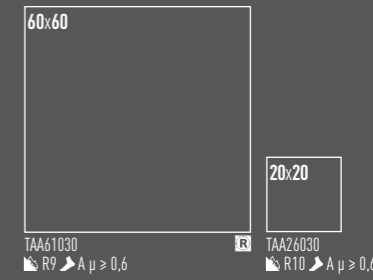
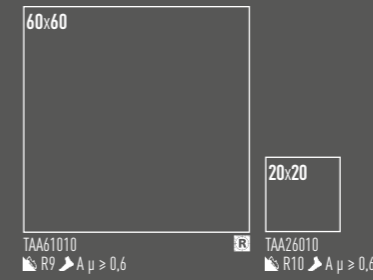
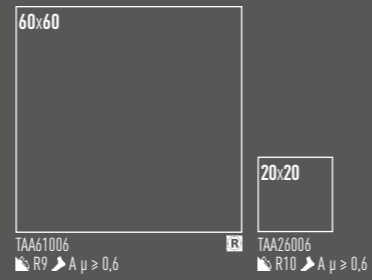
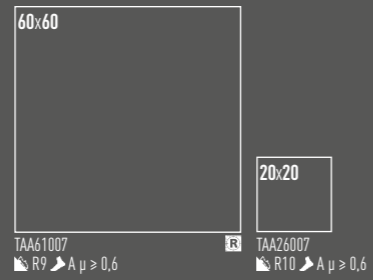
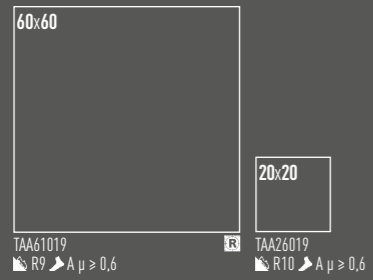

19 S Black

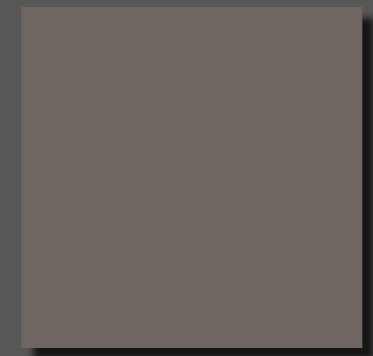

07 S Dark Grey

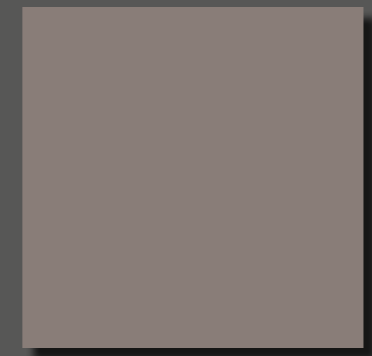

06 S Light Grey

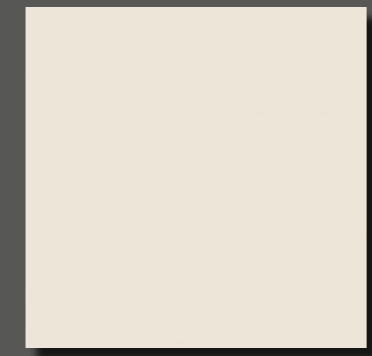

11 S Extra White



10 S Super White

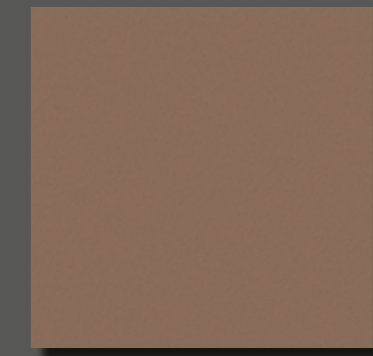

30 S Mocca



19 SL Black

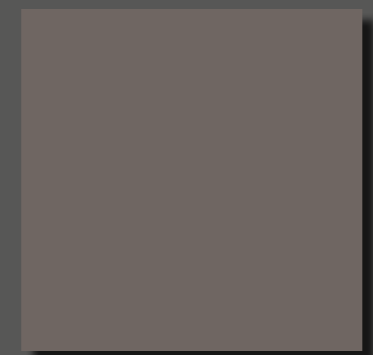

07 SL Dark Grey

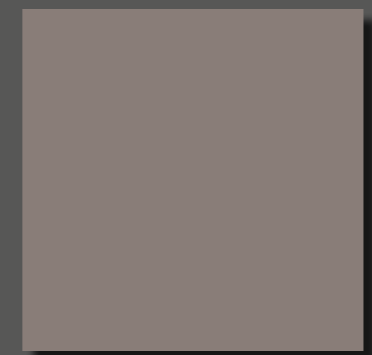

06 SL Light Grey

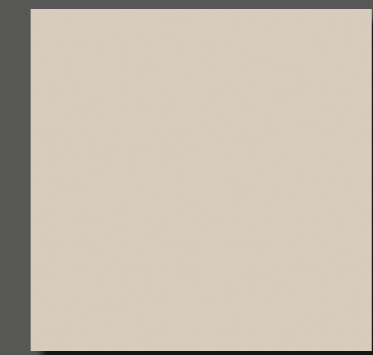

10 SL Super White

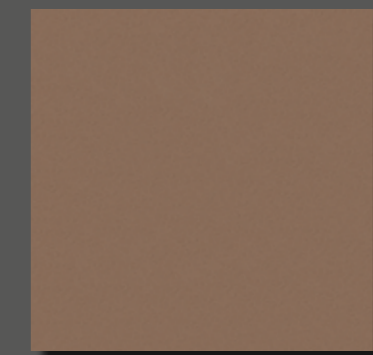

30 SL Mocca



Barevné odstíny, které jsou zde vyobrazeny, mají pouze orientační charakter. | The colour shades shown are for orientation only. | Odcienie kolorów, które są tu przedstawione, mają wyłącznie charakter orientacyjny. | Цвета/оттенки, изображенные в каталоге, носят ориентировочный характер. | A színárnyalat csak tájékoztató jellegű. | Colores, que se muestran aquí, son sólo indicativos.





schodovka | **TCP35...** | 298x298x9 mm
step tile | **TCP35...** | 298x298x9 mm

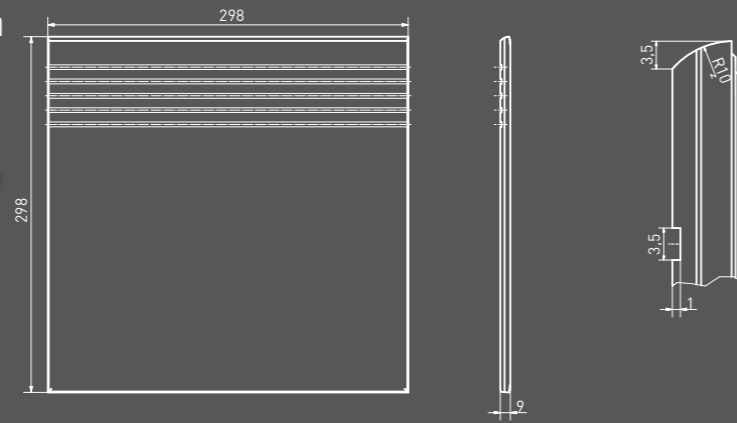
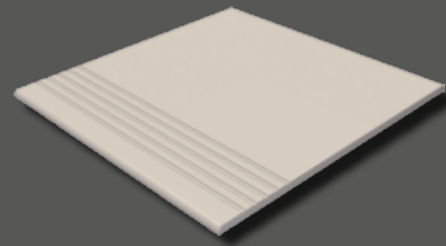

sokl | **TSAS4...** | 598x95x10 mm
skirting plinth | **TSAS4...** | 598x95x10 mm



sokl | **TSAJB...** | 298x80x9 mm
skirting plinth | **TSAJB...** | 298x80x9 mm

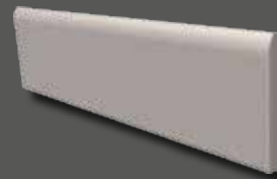

sokl s požlábkem | **TSPEM...** | 198x90x9 mm
cove skirting | **TSPEM...** | 198x90x9 mm

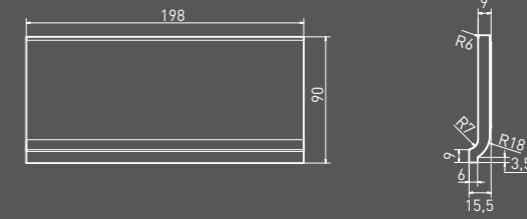
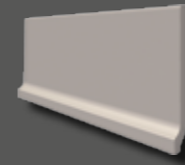

sokl vnitřní roh | **TSIRB...** | 23x90x10 mm
cove skirting inside corner | **TSIRB...** | 23x90x10 mm

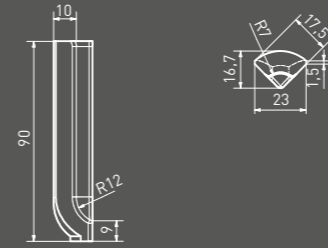

sokl vnější roh | **TSERB...** | 23x90x7 mm
cove skirting outside corner | **TSERB...** | 23x90x7 mm

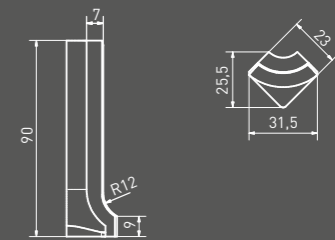

sokl s požlábkem | **TSPJB...** | 298x80x9 mm
cove skirting | **TSPJB...** | 298x80x9 mm

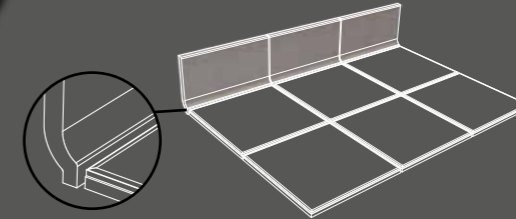
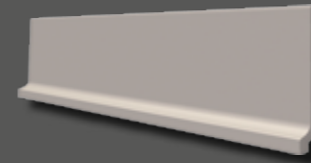

sokl vnitřní roh | **TSIRH...** | 23x80x10 mm
cove skirting inside corner | **TSIRH...** | 23x80x10 mm

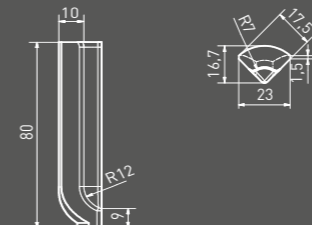

sokl vnější roh | **TSERH...** | 23x80x7 mm
cove skirting outside corner | **TSERH...** | 23x80x7 mm

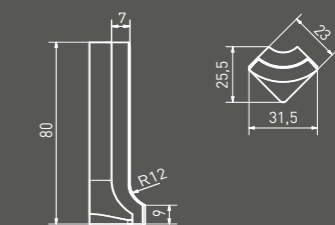



bezbariérová tvarovka rohová | **TTR12...** | 98x98x8 mm
 shower piece - corner | **TTR12...** | 98x98x8 mm

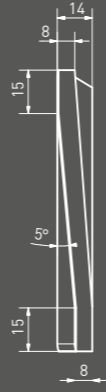
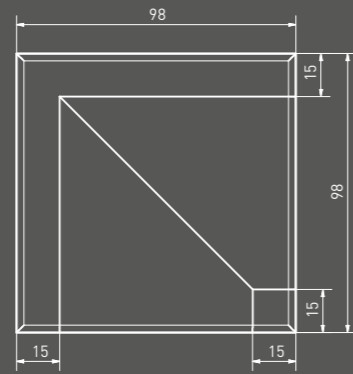

bezbariérová tvarovka průběžná | **TTP12...** | 98x98x8 mm
 shower piece - continuous | **TTP12...** | 98x98x8 mm

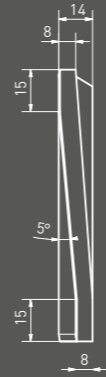
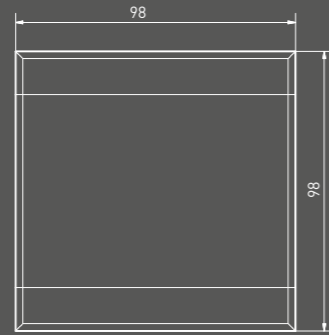

Logistická data | Logistic information

cm	mm	Výrobek Product	ks/m ²	m ²	kg	brutto kg				
5x5	48x48x9	mozaika set 30x30 cm mosaic sheet 30x30 cm	STO č. 030 - 049913	3	11	0,27	-	-	-	-
10x10	98x98x9	dlaždice floor tile	EN 14411:2012, annex G Bla UGL	11	11	1	56	56	19,2	1100
20x20	198x198x9	dlaždice floor tile	EN 14411:2012, annex G Bla UGL	25	25	1	57	57	19,2	1120
30x30	298x298x9	dlaždice (TAA35...) floor tile (TAA35...)	EN 14411:2012, annex G Bla UGL	12	11	1,09	48	52,32	21,0	1 033
30x30	295x295x8	dlaždice (TAL35...) floor tile (TAL35...)	EN 14411:2012, annex G Bla UGL	12	11	1,09	-	-	19,8	18,2
60x60	598x598x10	dlaždice floor tile	EN 14411:2012, annex G Bla UGL	3	2,8	1,08	32	34,56	25	23,1
30x30	298x298x9	schodovka step tile	STO č. 030 - 049916	11	11	1	52	52	19,2	1 024
60x9,5	598x95x10	sokl skirting plinth	STO č. 030 - 049916	13	17,5	0,74	-	-	15,9	21,5
30x8	298x80x9	sokl skirting plinth	STO č. 030 - 049916	21	42	0,5	77	38,5	9,5	19
20x9	198x90x9	sokl s pozábkem cove skirting	STO č. 030 - 049916	22	55	0,4	-	-	7,7	19,2
2,3x9	23x90x10	sokl vnitřní roh cove skirting inside corner	STO č. 030 - 049916	-	-	-	-	-	-	-
2,3x9	23x90x7	sokl vnější roh cove skirting outside corner	STO č. 030 - 049916	-	-	-	-	-	-	-
30x8	298x80x9	sokl s pozábkem cove skirting	STO č. 030 - 049916	21	42	0,5	77	38,5	9,5	19
2,3x8	23x80x10	sokl vnitřní roh cove skirting inside corner	STO č. 030 - 049916	-	-	-	-	-	-	-
2,3x8	23x80x7	sokl vnější roh cove skirting outside corner	STO č. 030 - 049916	-	-	-	-	-	-	-
10x10	98x98x9	bezbariérová tvarovka rohová shower piece - corner	STO č. 030 - 049916	16	100	0,16	-	-	2,2	13
10x10	98x98x9	bezbariérová tvarovka průběžná shower piece - continuous	STO č. 030 - 049916	16	100	0,16	-	-	2,2	13